

SAGINAW CONTROL & ENGINEERING

SCE-60XEL3716LP = SCE-09 GRAY
 SCE-60XEL3716LPLG = RAL 7035

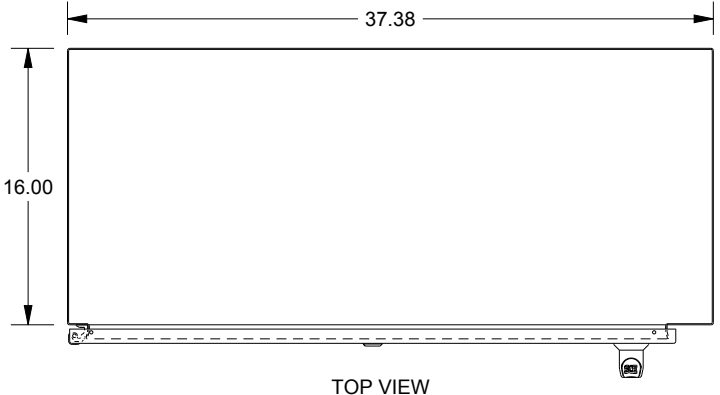

TOP VIEW

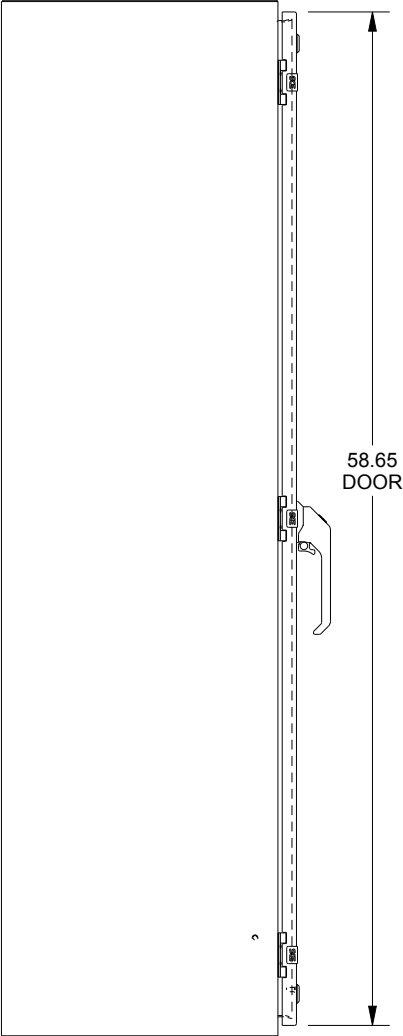

LEFT SIDE VIEW

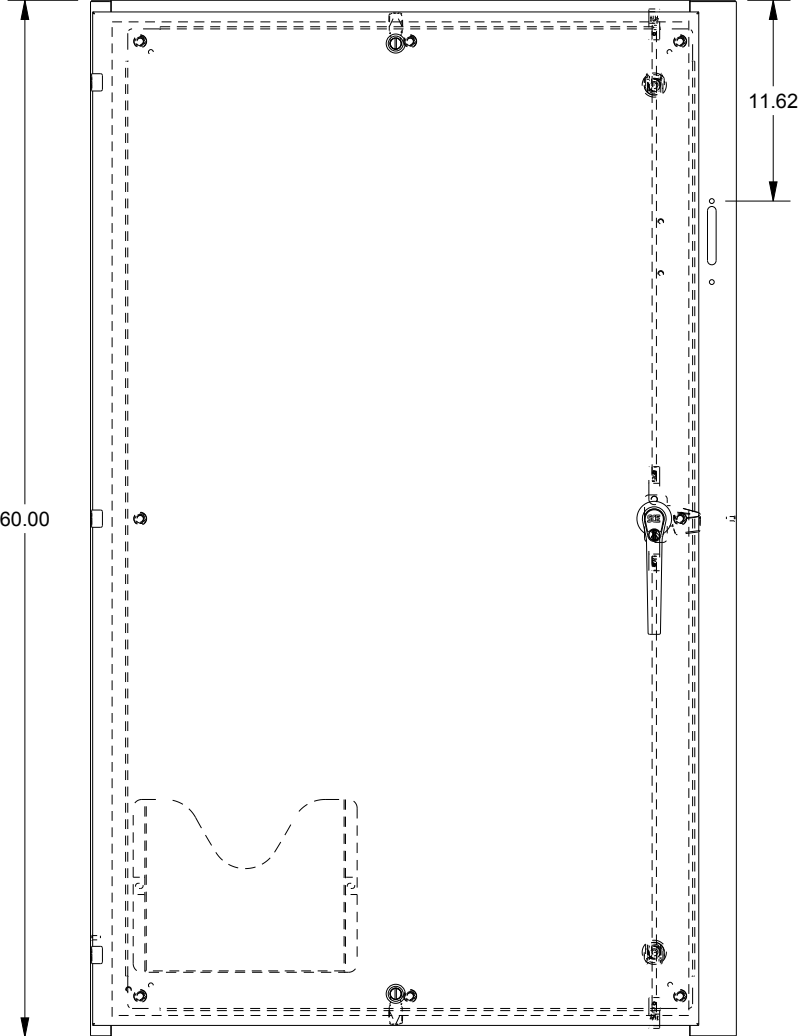

FRONT VIEW

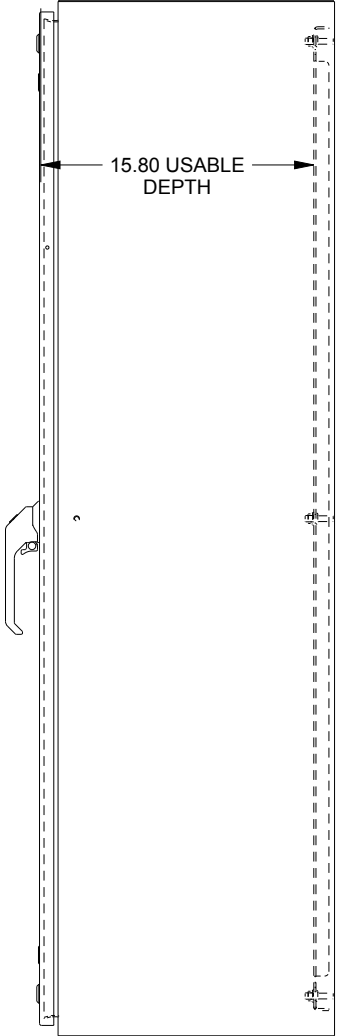

RIGHT SIDE VIEW

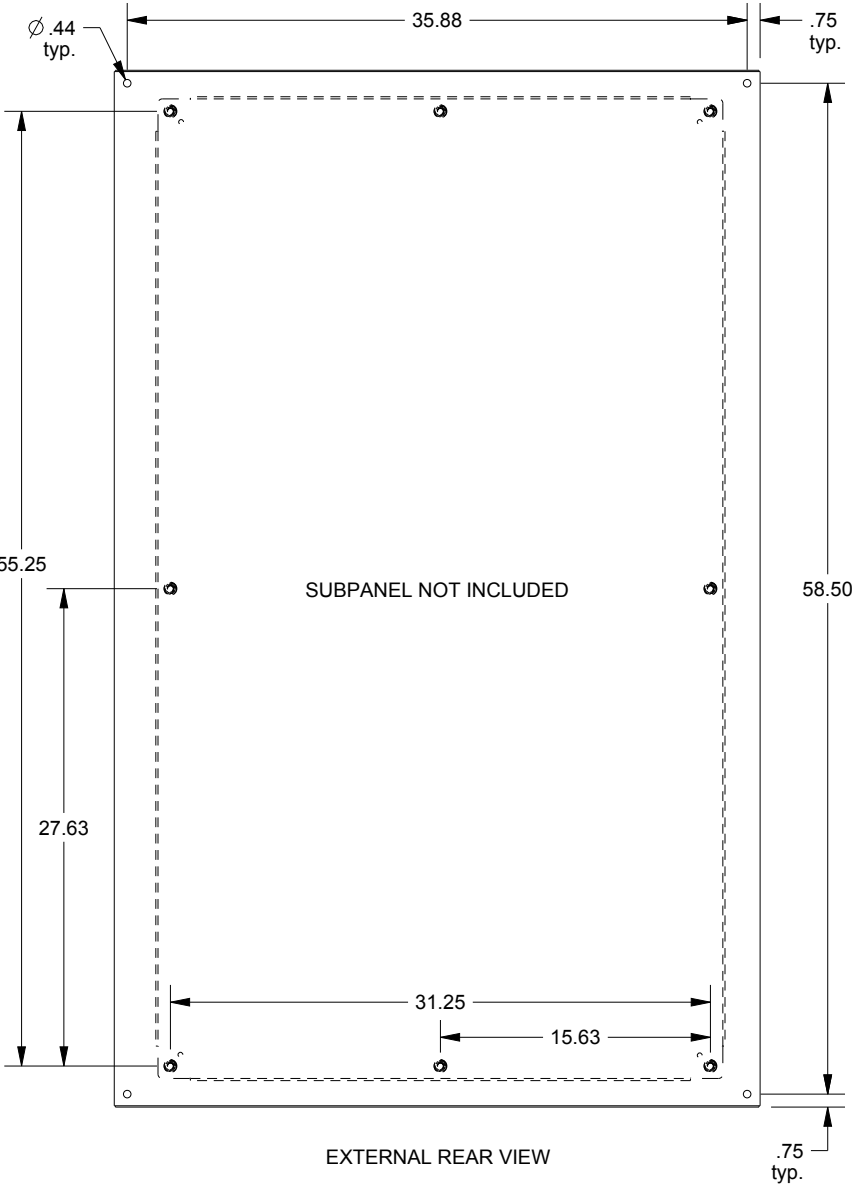

EXTERNAL REAR VIEW

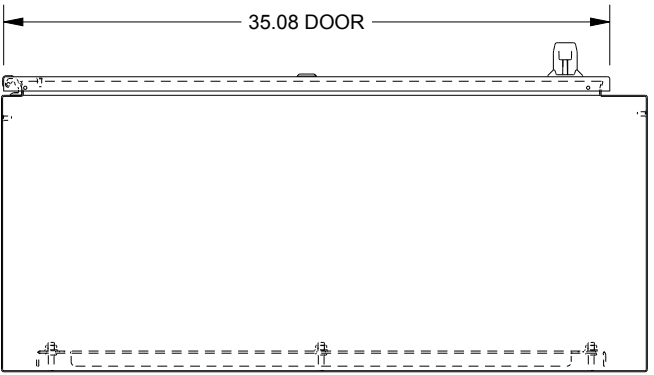

BOTTOM VIEW